



PHÖNIX

STRACK

DAUME
REGELARMATUREN



Solent & Pratt
Phoenix Ltd

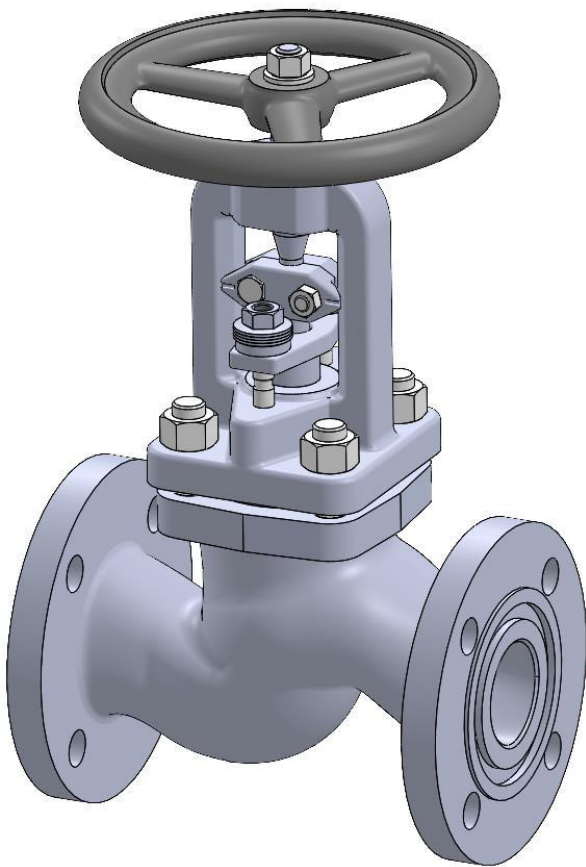

Globe Valve

Type 430.1

PN 160

Phönix Valve Group
Am Stadtbruch 6
34471 Volkmarsen

Phone:
web:
eMail:

+49 5693 988 0
www.phoenix-valvegroup.com
info@phoenix-valvegroup.com



Globe Valve / Type 430.1 Spring Loaded Stuffing Box

PN160 DN15 - DN150

CE 0525

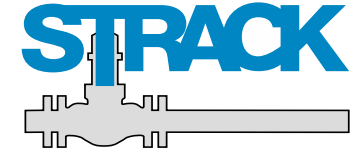

Design

- Stem sealed spring loaded stuffing box which enables a permanent and uniform compression of the packing
- Additional back seat at fully opened valve
- Spring unit protected against environment corrosion
- Rising handwheel
- Rotating disc with conic metal-to-metal seal

Dimensions

PN 160	Size / DN	15	20	25	32	40	50	65	80	100	125	150
	L	210	230	230	260	260	300	340	380	430	500	550
	H	255	250	260	328	335	350	430	495	570	570	785
	D	200	200	200	250	250	250	315	315	400	400	400
	Weight (kg)	16	16	17	23	23	29	45	55	85	90	108

Attention: italic nominal width with equilibrating disc, see appendix

Drag coefficient / Flow coefficient

Size / DN	15	20	25	32	40	50	65	80	100	125	150
ζ_v [-]	6,2	4,7	7,7	5,7	5,5	9,7	4,9	5,2	5	5,4	5,5
k_v [m ³ /h]	3,6	7,4	9	17	27	32	76	112	174	267	375

PHÖNIX reserves the right to change product design and specification without notice.

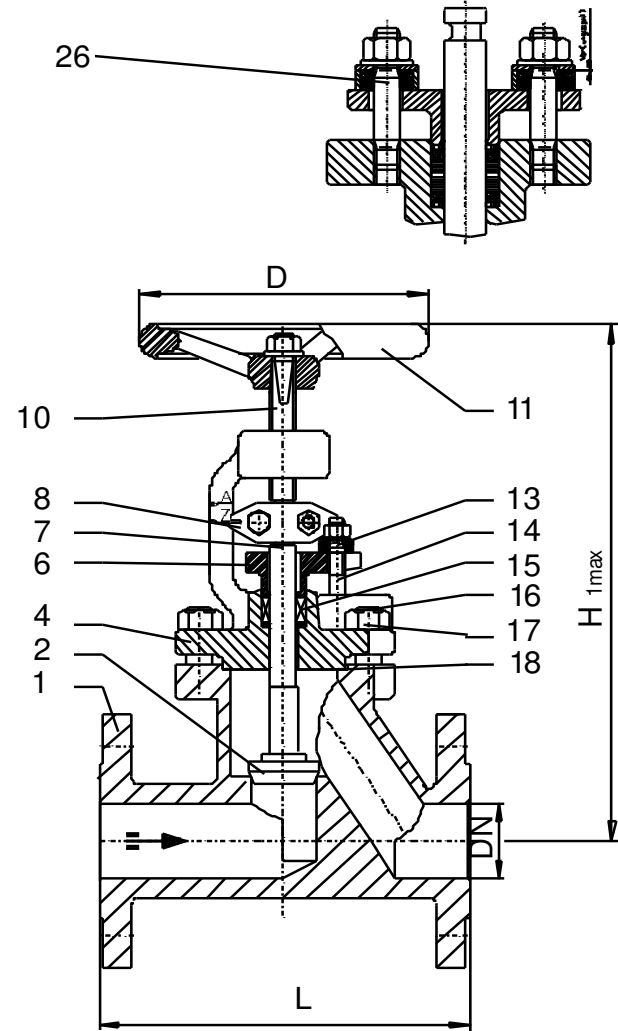

Globe Valve / Type 430.1 Spring Loaded Stuffing Box

PN16-PN160 DN15 - DN150

Materials



Item	Part name	Heat resistant carbon steel / Type 430.1 C		Stainless steel / Type 430.1V	
		Material * up to 450°C	DIN	Material * from -200°C up to 400°C	DIN
1	Body	P250GH G 18 8Mn (≈ 200 HRB)	1.0460	X2CrNiMo17-12-2	1.4404
	Overlay	GP240GH G 18 8Mn (≈ 200 HRB)	1.0619	GX5CrNiMo19-11-2 -	1.4408 -
2	Disc	X20Cr13 hardened	1.4021	X6CrNiMoTi17-12-2	1.4571
	Overlay	P250GH G Z 13 (≈ 300 HRB)	1.0460 1.4009	Stellite 6 (≈ 42 HRC)	
4	Bonnet ≤ DN 65 > DN 65	P250GH	1.0460	X2CrNiMo17-12-2	1.4404
		GP240GH	1.0619	GX5CrNiMo19-11-2	1.4408
6	Gland follower	GP240GH	1.0619	X6CrNiMoTi17-12-2	1.4571
7	Lower stem	X6CrNiMoTi17-12-2	1.4571	X6CrNiMoTi17-12-2	1.4571
8	Coupling	GX5CrNiMo19-11-2	1.4408	GX5CrNiMo19-11-2	1.4408
10	Upper stem	X17CrNi16-2	1.4057	X17CrNi16-2	1.4057
11	Handwheel	EN-GJS-400-15	0.7040	EN-GJS-400-15	0.7040
13	Hex.nut	Steel	5	A4-70	
14	Stud bolt	Steel	5.6	A4-70	
15	Packing	Graphite		Graphite	
16	Stud bolt	21CrMoV5-7	1.7709	A4-70	
17	Hex.nut	25CrMo4	1.7218	A4-70	
18	Bonnet gasket	Kammprofil / Graphite + S.S.		Kammprofil / Graphite + S.S.	
26	Disc spring package	50 CrV 4	1.8159	50 CrV 4	1.8159

Special materials on request.

Marking EN19, AD-A4, CE

Face-to-face dimensions

Flanged option

Butt weld ends

Socket weld ends

Connections

Flanged option

Butt weld ends

Socket weld ends

Testing standard

AD-2000, DIN 3230 section 3, DIN EN 12266

PHÖNIX reserves the right to change product design and specification without notice.

* Pressure-temperature-rating see appendix

** ≥ 220°C Packing of pure graphite

Contact us

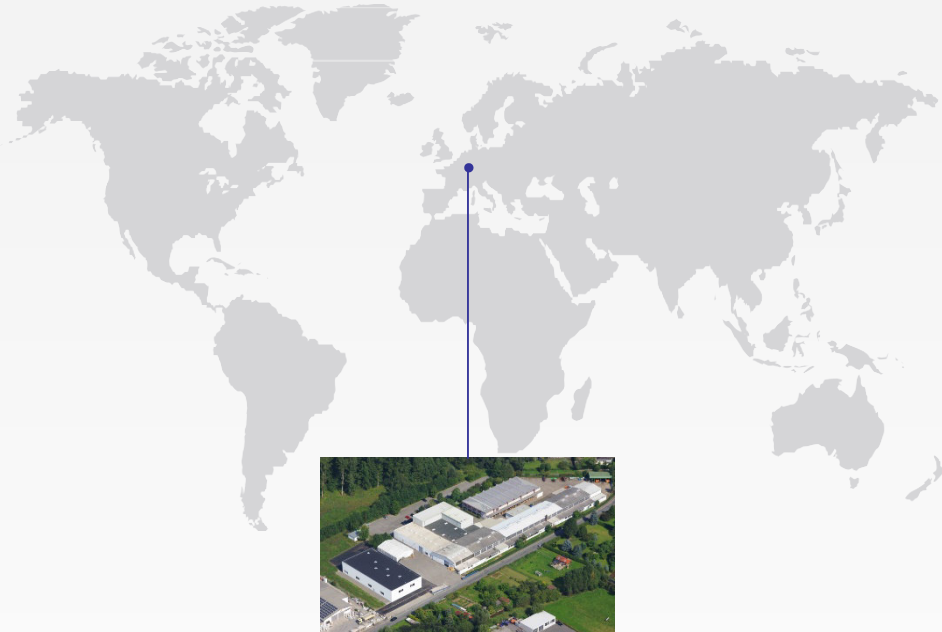

Volkmarsen, Germany

Sales and Operations

Phönix Valve Group GmbH

Volkmarsen, Germany
Phone: +49 5693 988 0
Email: info@phoenix-valvegroup.com
Website: www.phoenix-valvegroup.com

Phönix Armaturen Werke-Bregel GmbH

Volkmarsen, Germany
Phone: +49 5693 988 0
Email: info@phoenix-valvegroup.com
Website: www.phoenix-valvegroup.com

Strack GmbH

Volkmarsen, Germany
Phone: +49 5693 988 0
Email: info@phoenix-valvegroup.com
Website: www.phoenix-valvegroup.com

PAW SARL

Genay Cedex, France
Phone: +33 437 408 195
Email: commercial@phoenix-valvegroup.com
Website: www.phoenix-valvegroup.com

Daume Regelarmaturen GmbH

Volkmarsen, Germany
Phone: +49 5693 988 0
Email: info@phoenix-valvegroup.com
Website: www.phoenix-valvegroup.com

Solent & Pratt Phönix Ltd.

Volkmarsen, Germany
Phone: +49 5693 988 0
Email: info@phoenix-valvegroup.com
Website: www.phoenix-valvegroup.com



While this information is presented in good faith and believed to be accurate, Phönix Valve Group GmbH, does not guarantee satisfactory results from reliance on such information. Nothing contained herein is to be construed as a warranty or guarantee, expressed or implied, regarding the performance, merchantability, fitness or any other matter with respect to the products, nor as a recommendation to use any product or process in conflict with any patent. Phönix Valve Group GmbH, reserves the right, without notice, to alter or improve the designs or specifications of the products described herein.

© 2022 Phönix Valve Group. All rights reserved. Specifications are subject to change without notice. All trademarks are property of their respective owners

Printed in Germany
09/22-R0