



PHÖNIX

STRACK

DAUME
REGELARMATUREN

SIP Solent & Pratt
Phönix Ltd

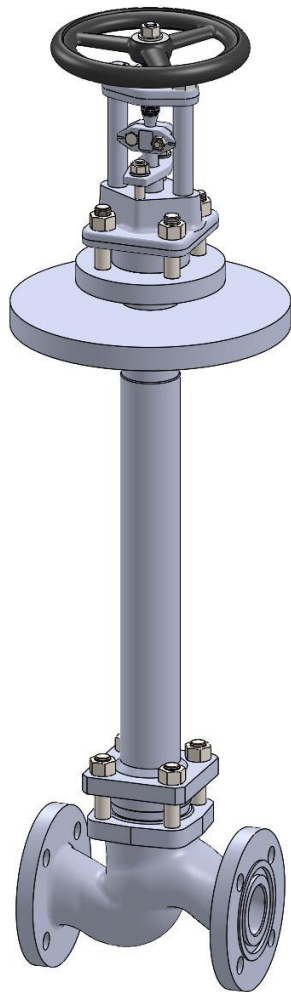

Globe Valve

Type 919

PN 40

Phönix Valve Group
Am Stadtbruch 6
34471 Volkmarsen

Phone:
web:
eMail:

+49 5693 988 0
www.phoenix-valvegroup.com
info@phoenix-valvegroup.com



Globe valve / Type 919 for cryogenic application

PN40 DN15 - DN150

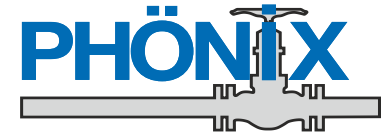

CE 0525

Design

Long isolating distance and extractable displacer for use in refrigerating circuits and air separation plans

Stuffing box

Additional back seat at fully opened valve as secondary sealing

Lower stem with or without displacement body

Rotating disc with conic metal-to-metal seal

Dimensions

PN40	Size / DN	15	20	25	32	40	50	65	80	100	125	150
	L	130	150	160	180	200	230	290	310	350	400	480
H	605	605	605	670	670	670	680	930	1000	1000	1300	
D	150	150	150	200	200	200	200	250	315	315	400	
A	300	300	300	300	300	300	300	600	600	600	600	
Weight (kg)	9,5	10	11	17	19	22	31,5	41	63	98	129	

Drag coefficient / Flow coefficient

Size / DN	15	20	25	32	40	50	65	80	100	125	150
$\zeta_v [-]$	6,9	5,1	8,9	5,1	9,1	10	4,6	5	4,9	5,9	4,9
$k_v [m^3/h]$	3,4	7	8,3	18	21	31	78	113	179	256	405

PHÖNIX reserves the right to change product design and specification without notice.

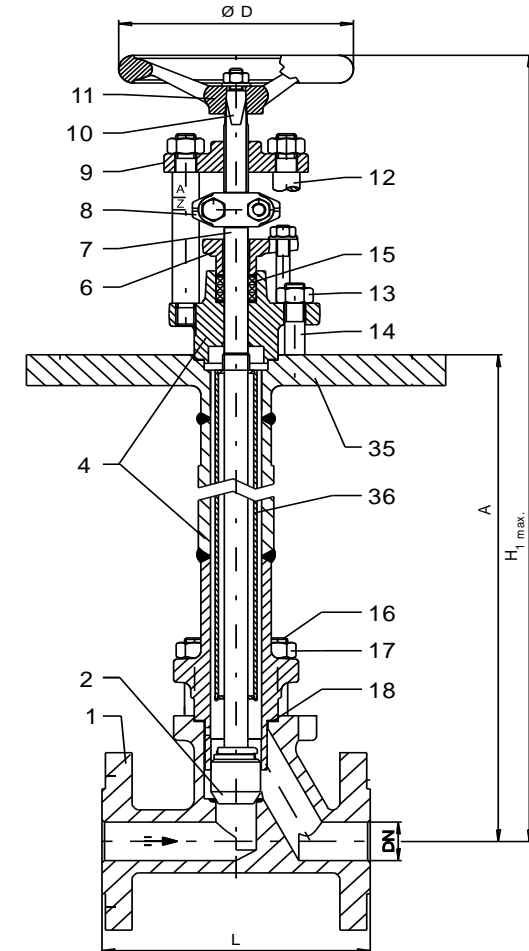

Globe valve / Type 919 for cryogenic application

PN16/ 25/ 40 DN15 - DN150

Materials



		Stainless steel / Type 919 V	
Item	Part name	Material * from -200°C up to 400°C	DIN
1	Body	X2CrNiMo17-12-2	1.4404
	Overlay	GX5CrNiMo19-11-2 like body (≈ 200 HRB)	1.4408
2	Disc	X 6CrNiMoTi17-12-2	1.4571
	Overlay	- ***	
4	Bonnet	X2CrNiMo17-12-2	1.4404
6	Gland follower	GX5CrNiMo19-11-2	1.4408
7	Lower Stem	X6CrNiMoTi17-12-2	1.4571
8	Coupling	GX5CrNiMo19-11-2	1.4408
9	Bridge	P250GH / QPQ-nitrited	1.0460
10	Upper Stem	X17CrNi16-2	1.4057
11	Handwheel	EN-GJS-400-15	0.7040
12	Pillar	X17CrNi16-2	1.4057
13	Hex.nut	A4-70	
14	Stud bolt	A4-70	
15	Packing	PTFE-Silk**	
16	Stud bolt	A4-70	
17	Hex.nut	A4-70	
18	Bonnet gasket	Kammprofil / Stainless steel / PTFE	
35	Flange for cryogenic	X2CrNiMo17-12-2	1.4404
36	Displacement body	X2CrNiMo17-12-2	1.4404

* Pressure-temperature-rating see appendix

** ≥ 220°C Packing of pure graphite

*** on request Stellite 6 (≈ 42 HRC)

Special materials on request.

Specification

Marking:

EN19, AD-A4, CE

Face-to-face dimensions:

Flanged option

DIN EN 558-1

Butt weld ends

DIN EN 12982 up to PN100

Socket weld ends

Connections:

Flanged option

DIN EN 1092-1 up to PN100

Butt weld ends

DIN EN 12627

Socket weld ends

DIN EN 12760

Testing standard:

AD-2000, DIN 3230 section 3, DIN EN 12266

PHÖNIX reserves the right to change product design and specification without notice.

Contact us



Volkmarsen, Germany

Sales and Operations

Phönix Valve Group GmbH

Volkmarsen, Germany
Phone: +49 5693 988 0
Email: info@phoenix-valvegroup.com
Website: www.phoenix-valvegroup.com

Phönix Armaturen Werke-Bregel GmbH

Volkmarsen, Germany
Phone: +49 5693 988 0
Email: info@phoenix-valvegroup.com
Website: www.phoenix-valvegroup.com

Strack GmbH

Volkmarsen, Germany
Phone: +49 5693 988 0
Email: info@phoenix-valvegroup.com
Website: www.phoenix-valvegroup.com

PAW SARL

Genay Cedex, France
Phone: +33 437 408 195
Email: commercial@phoenix-valvegroup.com
Website: www.phoenix-valvegroup.com

Daume Regelarmaturen GmbH

Volkmarsen, Germany
Phone: +49 5693 988 0
Email: info@phoenix-valvegroup.com
Website: www.phoenix-valvegroup.com

Solent & Pratt Phönix Ltd.

Volkmarsen, Germany
Phone: +49 5693 988 0
Email: info@phoenix-valvegroup.com
Website: www.phoenix-valvegroup.com



While this information is presented in good faith and believed to be accurate, Phönix Valve Group GmbH, does not guarantee satisfactory results from reliance on such information. Nothing contained herein is to be construed as a warranty or guarantee, expressed or implied, regarding the performance, merchantability, fitness or any other matter with respect to the products, nor as a recommendation to use any product or process in conflict with any patent. Phönix Valve Group GmbH, reserves the right, without notice, to alter or improve the designs or specifications of the products described herein.

© 2022 Phönix Valve Group. All rights reserved. Specifications are subject to change without notice. All trademarks are property of their respective owners

Printed in Germany
09/22-R0