



PHÖNIX

STRACK

DAUME
REGELARMATUREN

SIP Solent & Pratt
Phönix Ltd

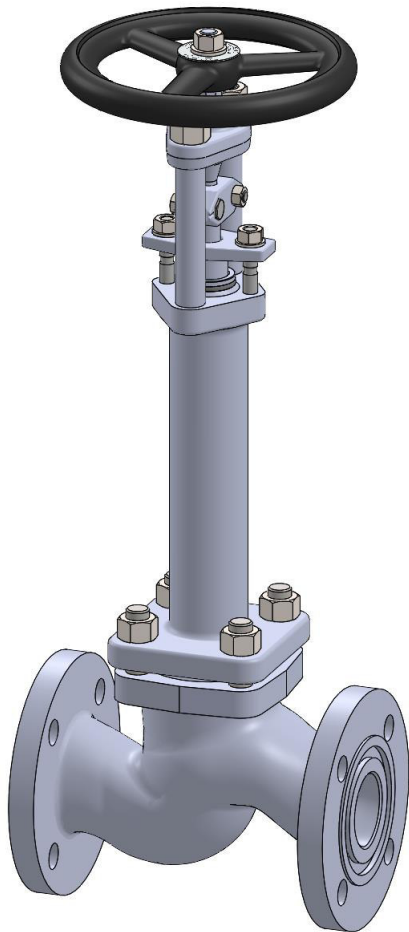

Globe Valve

Type 941

PN 16

Phönix Valve Group
Am Stadtbruch 6
34471 Volkmarsen

Phone:
web:
eMail:

+49 5693 988 0
www.phoenix-valvegroup.com
info@phoenix-valvegroup.com



Globe valve / Type 941 for cryogenic application

PN16 DN15 - DN150



Design

Long isolating distance for use in refrigerating circuits and air separation plans

Bellows highly protected

Up to 50.000 operations guaranteed

Multiple-wall bellows, protected against torquing

Additional emergency stuffing box

Rotating disc with conic metal-to-metal seal

CE 0525

Dimensions

PN16	Size / DN	15	20	25	32	40	50	65	80	100	125	150
	L	130	150	160	180	200	230	290	310	350	400	480
H	630	630	630	670	670	670	690	910	950	950	1080	
ØD	150	150	150	200	200	200	200	250	315	315	400	
A	300	300	300	300	300	300	300	600	600	600	600	
Weight (kg)	8	9	10	16	18	21	30	41	62	98	128	

Drag coefficient / Flow coefficient

Size / DN	15	20	25	32	40	50	65	80	100	125	150
ζ_v [-]	6,9	5,1	8,9	5,1	9,1	10,2	4,6	5	4,9	5,9	4,9
k_v [m³/h]	3,4	7	8,3	18	21	31	78	113	179	256	405

PHÖNIX reserves the right to change product design and specification without notice.

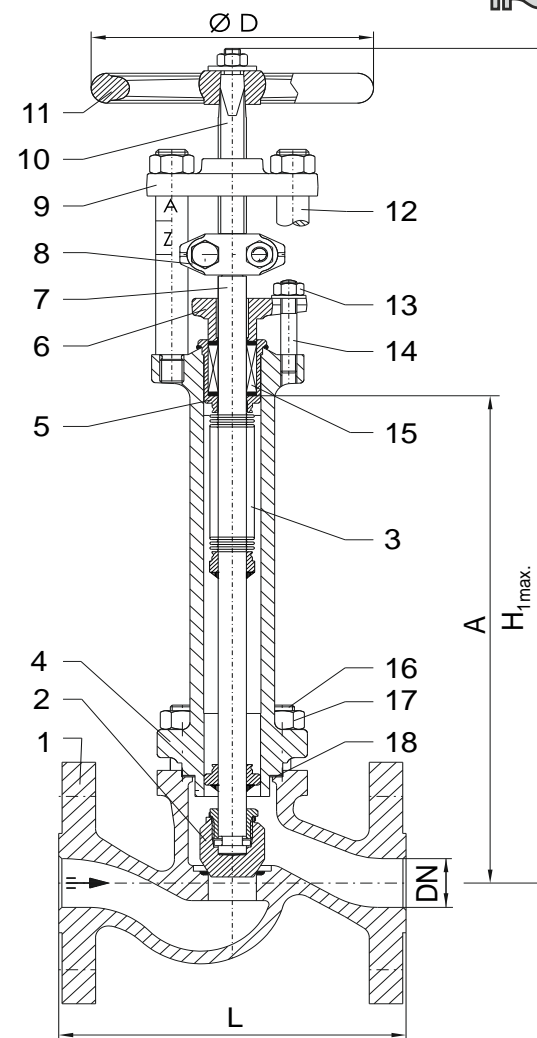

Globe valve / Type 941 for cryogenic application

PN16/ 25/ 40/ 63/ 100/ 160 DN15 - DN150

Materials



		Stainless steel / Type 941 V	
Item	Part name	Material * from -200°C up to 400°C	DIN
1	Body	X2CrNiMo17-12-2	1.4404
	Overlay	GX5CrNiMo19-11-2 like body (≈ 200 HRB)	1.4408
2	Disc	X6CrNiMoTi17-12-2	1.4571
	Overlay	_ ***	
3	Bellows	X6CrNiMoTi17-12-2	1.4571
4	Bonnet	X2CrNiMo17-12-2	1.4404
5	Stuffing box body	X6CrNiMoTi17-12-2	1.4571
6	Gland follower	GX5CrNiMo19-11-2	1.4408
7	Lower Stem	X6CrNiMoTi17-12-2	1.4571
8	Coupling	GX5CrNiMo19-11-2	1.4408
9	Bridge	P250GH / QPQ-nitrited	1.0460
10	Upper Stem	X17CrNi16-2	1.4057
11	Handwheel	EN-GJS-400-15	0.7040
12	Pillar	X17CrNi16-2	1.4057
13	Hex.nut	A4-70	
14	Stud bolt	A4-70	
15	Packing	PTFE-Silk**	
16	Stud bolt	A4-70	
17	Hex.nut	A4-70	
18	Bonnet gasket	Kamprofil / Stainless steel / PTFE	

* Pressure-temperature-rating see appendix

** ≥ 220°C Packing of pure graphite

*** on request Stellite 6 (≈ 42 HRC)

Special materials on request.

Specification

Marking:		EN19, AD-A4, CE
Face-to-face dimensions:	Flanged option	DIN EN 558-1
	Butt weld ends	DIN EN 12982 up to PN100
	Socket weld ends	
Connections:	Flanged option	DIN EN 1092-1 up to PN100 / DIN 2512 PN160
	Butt weld ends	DIN EN 12627
	Socket weld ends	DIN EN 12760
Testing standard		AD-2000, DIN 3230 section 3, DIN EN 12266

PHÖNIX reserves the right to change product design and specification without notice.

PHÖNIX • P +49 5693 988-0 • F +49 5693 988-178 • info@phoenix-valvegroup.com • https://phoenix-valvegroup.com

Contact us



Volkmarsen, Germany

Sales and Operations

Phönix Valve Group GmbH

Volkmarsen, Germany
Phone: +49 5693 988 0
Email: info@phoenix-valvegroup.com
Website: www.phoenix-valvegroup.com

Phönix Armaturen Werke-Bregel GmbH

Volkmarsen, Germany
Phone: +49 5693 988 0
Email: info@phoenix-valvegroup.com
Website: www.phoenix-valvegroup.com

Strack GmbH

Volkmarsen, Germany
Phone: +49 5693 988 0
Email: info@phoenix-valvegroup.com
Website: www.phoenix-valvegroup.com

PAW SARL

Genay Cedex, France
Phone: +33 437 408 195
Email: commercial@phoenix-valvegroup.com
Website: www.phoenix-valvegroup.com

Daume Regelarmaturen GmbH

Volkmarsen, Germany
Phone: +49 5693 988 0
Email: info@phoenix-valvegroup.com
Website: www.phoenix-valvegroup.com

Solent & Pratt Phönix Ltd.

Volkmarsen, Germany
Phone: +49 5693 988 0
Email: info@phoenix-valvegroup.com
Website: www.phoenix-valvegroup.com



While this information is presented in good faith and believed to be accurate, Phönix Valve Group GmbH, does not guarantee satisfactory results from reliance on such information. Nothing contained herein is to be construed as a warranty or guarantee, expressed or implied, regarding the performance, merchantability, fitness or any other matter with respect to the products, nor as a recommendation to use any product or process in conflict with any patent. Phönix Valve Group GmbH, reserves the right, without notice, to alter or improve the designs or specifications of the products described herein.

© 2022 Phönix Valve Group. All rights reserved. Specifications are subject to change without notice. All trademarks are property of their respective owners

Printed in Germany
09/22-R0