



PHÖNIX

STRACK

DAUME
REGELARMATUREN



Solent & Pratt
Phönix Ltd

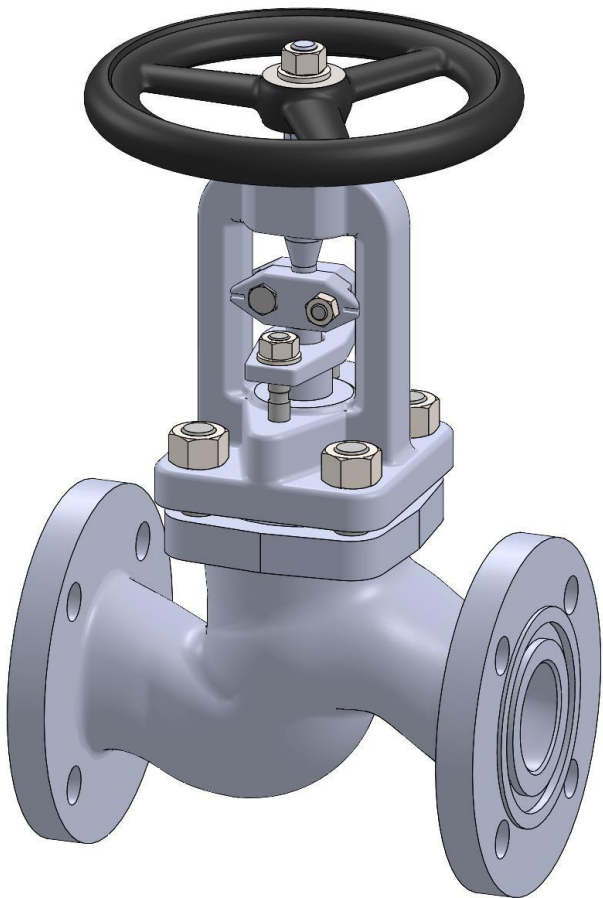

Globe Valve

Type S20/ S24/ 430

PN 16

Phönix Valve Group
Am Stadtbruch 6
34471 Volkmarsen

Phone:
web:
eMail:

+49 5693 988 0
www.phoenix-valvegroup.com
info@phoenix-valvegroup.com



Globe Valve S20/ S24/ 430

PN16 DN65 - DN300



Design

Globe valve, Straight-way type

Flanged ends

Stem sealed by stuffing box

Coupling divided stem, rising handwheel

Disc with conic metal-to-metal seal

Additional back seat at fully opened valve

Dimensions

PN16	Size / DN	65	80	100	125	150	200	250	300
	L	290	310	350	400	480	600	730	850
	H	415	475	555	555	720	745	850	950
	D	200	250	315	315	400	500	500	600
	Weight (kg)	23	30	50	85	110	205	342	406

Drag coefficient / Flow coefficient

Size / DN	65	80	100	125	150	200	250	300
ζ_v [-]	4,9	5,2	5	5,4	5,5	5,2	5,6	o. r.
k_v [m ³ /h]	76	112	179	267	375	693	1047	

PHÖNIX reserves the right to change product design and specification without notice.

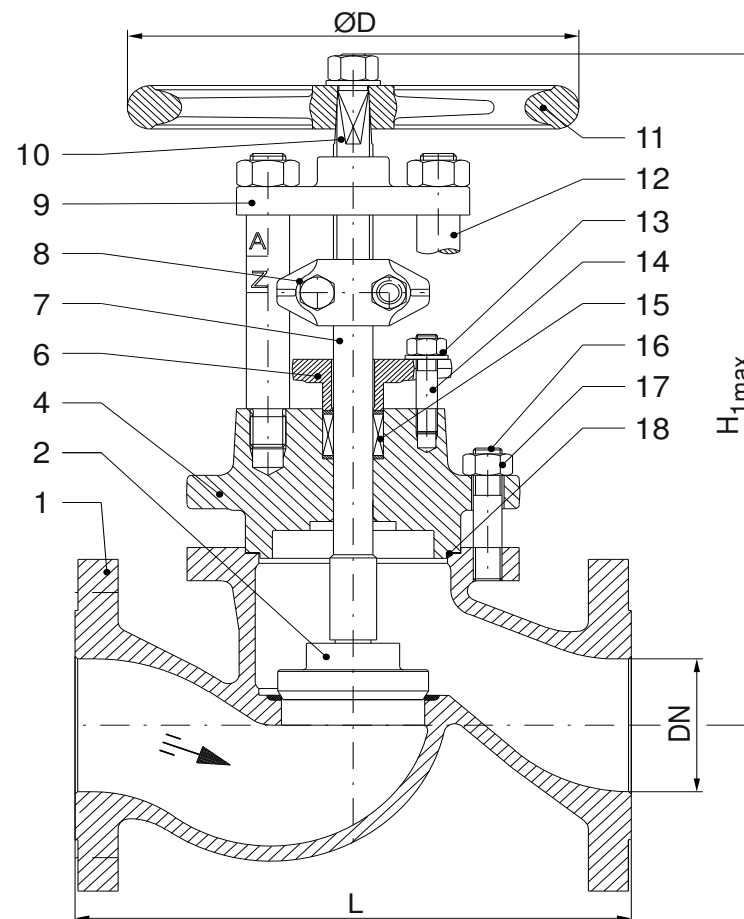

Globe Valve S20/ S24/ 430

PN16 - PN160 DN65 - DN300

Materials



Item	Part name	Heat resistant carbon steel				Low temperature steel		Stainless steel	
		Material * up to 400°C	DIN	Material * from -10°C up to 500°C	DIN	Material * from -50°C up to 300°C	DIN	Material * from -200°C up to 400°C	DIN
1	Body	GP240GH	1.0619	G12CMo19-5	1.7363	G21Mn 5	1.1138	GX5CrNiMo19-11-2	1.4408
	Overlay	G 18 8Mn (≈ 200 HRB)	1.4370	Stellite 21 (≈ 32 HRC)		G 18 8Mn (≈ 200 HRB)	1.4370	-	-
2	Disc	P250GH	1.0460	12CrMo19-5	1.7362	X6CrNiMoTi17-12-2	1.4571	X6CrNiMoTi17-12-2	1.4571
	Overlay	G Z 13 (≈ 300 HRB)	1.4009	Stellite 6 (≈ 42 HRC)		Stellite 6 (≈ 42 HRC)		Stellite 6 (≈ 42 HRC)	
4	Bonnet	GP240GH	1.0619	G12CMo19-5	1.7363	G21Mn 5	1.1138	GX5CrNiMo19-11-2	1.4408
6	Gland follower	GP240GH	1.0619	GP240GH	1.0619	G9Ni14	1.5638	X6CrNiMoTi17-12-2	1.4571
7	Lower Stem	X20Cr13	1.4021	X20CrMoV11-1	1.4922	X6CrNiMoTi17-12-2	1.4571	X6CrNiMoTi17-12-2	1.4571
8	Coupling	GX5CrNiNb19-10	1.4552	GX5CrNiNb19-10	1.4552	GX5CrNiNb19-10	1.4552	GX5CrNiNb19-10	1.4552
10	Upper Stem	X17CrNi16-2	1.4057	X17CrNi16-2	1.4057	X17CrNi16-2	1.4057	X17CrNi16-2	1.4057
11	Handwheel	EN-GJS-400-15	0.7040	EN-GJS-400-15	0.7040	EN-GJS-400-15	0.7040	EN-GJS-400-15	0.7040
13	Hex.nut	Steel	5	21CrMoV5-7	1.7709	A4-70		A4-70	
14	Stud bolt	Steel	5.6	25CrMo4	1.7218	A4-70		A4-70	
15	Packing	Graphite		Graphite		PTFE-Silk**		Graphite	
16	Stud bolt	21CrMoV5-7	1.7709	21CrMoV5-7	1.7709	A4-70		A4-70	
17	Hex.nut	25CrMo4	1.7218	25CrMo4	1.7218	A4-70		A4-70	
18	Bonnet gasket	Kammprofil / Graphite + S.S.		Kammprofil / Graphite + S.S.		Kammprofil / Graphite + S.S.		Kammprofil / Graphite + S.S.	

Special materials on request

* Pressure-temperature-rating see appendix

** ≥ 220°C Packing of pure graphite

Specification

Marking	EN19, AD-A4, CE
Face-to-face dimensions	
Flanged option	DIN EN 558-1
Butt weld ends	DIN EN 12982 up to PN100
Socket weld ends	
Connections	
Flanged option	DIN EN 1092-1 up to PN100 / DIN 2512 PN160
Butt weld ends	DIN EN 12627
Socket weld ends	DIN EN 12760
Testing standard	AD-2000, DIN 3230 section 3, DIN EN 12266

PHÖNIX reserves the right to change product design and specification without notice.

PHÖNIX • P +49 5693 988-0 • F +49 5693 988-178 • info@phoenix-valvegroup.com • https://phoenix-valvegroup.com

Contact us



Volkmarsen, Germany

Sales and Operations

Phönix Valve Group GmbH

Volkmarsen, Germany
Phone: +49 5693 988 0
Email: info@phoenix-valvegroup.com
Website: www.phoenix-valvegroup.com

Phönix Armaturen Werke-Bregel GmbH

Volkmarsen, Germany
Phone: +49 5693 988 0
Email: info@phoenix-valvegroup.com
Website: www.phoenix-valvegroup.com

Strack GmbH

Volkmarsen, Germany
Phone: +49 5693 988 0
Email: info@phoenix-valvegroup.com
Website: www.phoenix-valvegroup.com

PAW SARL

Genay Cedex, France
Phone: +33 437 408 195
Email: commercial@phoenix-valvegroup.com
Website: www.phoenix-valvegroup.com

Daume Regelarmaturen GmbH

Volkmarsen, Germany
Phone: +49 5693 988 0
Email: info@phoenix-valvegroup.com
Website: www.phoenix-valvegroup.com

Solent & Pratt Phönix Ltd.

Volkmarsen, Germany
Phone: +49 5693 988 0
Email: info@phoenix-valvegroup.com
Website: www.phoenix-valvegroup.com



While this information is presented in good faith and believed to be accurate, Phönix Valve Group GmbH, does not guarantee satisfactory results from reliance on such information. Nothing contained herein is to be construed as a warranty or guarantee, expressed or implied, regarding the performance, merchantability, fitness or any other matter with respect to the products, nor as a recommendation to use any product or process in conflict with any patent. Phönix Valve Group GmbH, reserves the right, without notice, to alter or improve the designs or specifications of the products described herein.

© 2022 Phönix Valve Group. All rights reserved. Specifications are subject to change without notice. All trademarks are property of their respective owners

Printed in Germany
09/22-R0